

Broiler





BROILER

With TAVSAN pan feeding systems you achieve the best feed conversion rates starting from the first day until the end. Tavsan pan feeders offer minimum feed loss, easy cleaning and easy feed height level adjustment.

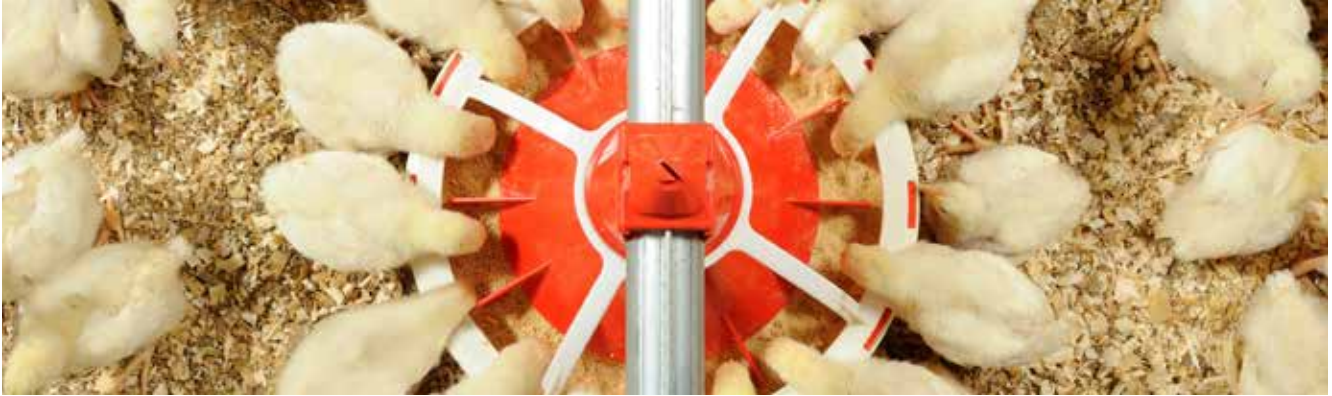

Pan feeding hoppers are offered with two different capacities; 90 kg and 170 kg. to supply the needed feed to the pan feeding lines.



The pan feeding system can also be supplied with "Double Outlet Hoppers" for mid-line installations. The body sheet thickness of the hopper is 1 mm and the bottom part is 1,5 mm where both has 275 gr/m² galvanization ratio.

Pan feeding pipe is produced from 1,2mm galvanized sheet with 275 gr/m² galvanization ratio. The rim on the feeding pipe does not allow the feed pan to swing on the pipe and cause feed loss.

The mechanical switch in the end-pan stops the motor automatically when all the pans are filled with feed and restarts the motor when the feed pans are empty.

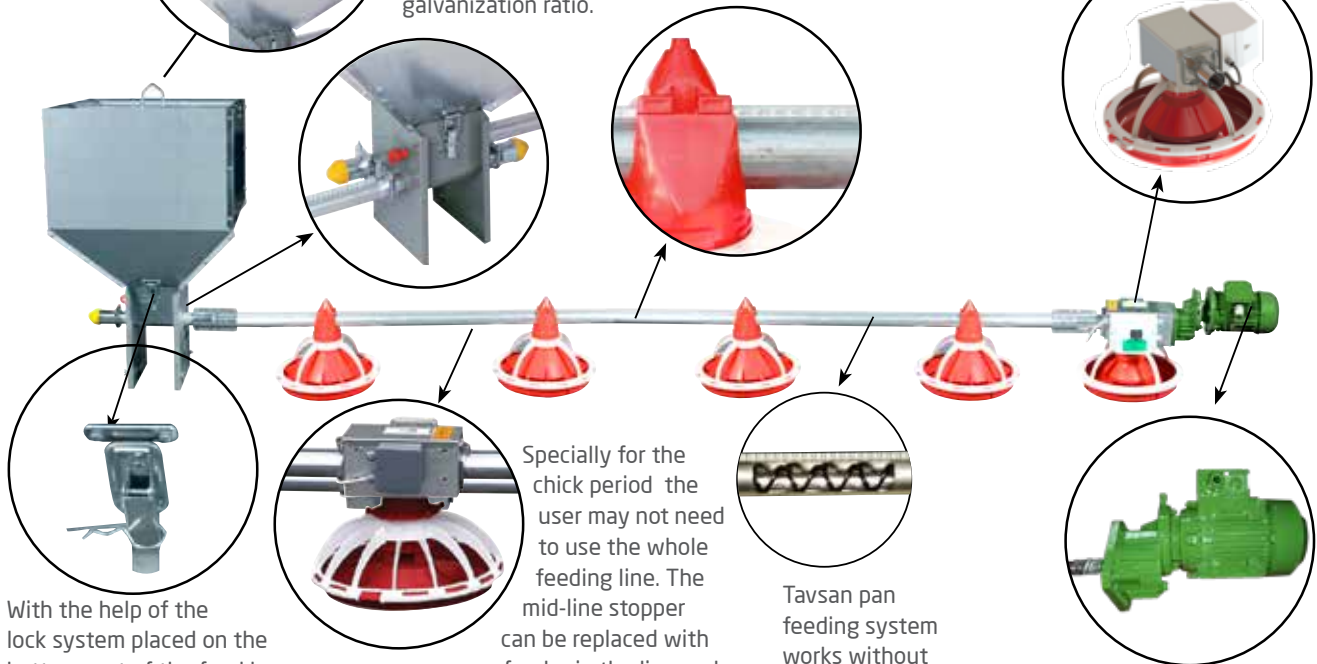

With the help of the lock system placed on the bottom part of the feed hopper, the user is able to separate the upper part of the hopper from the bottom part easily and let the feeding line to be lifted up in maximum level on the ceiling. This allows the user to have an easy litter cleaning.

Specially for the chick period the user may not need to use the whole feeding line. The mid-line stopper can be replaced with any feeder in the line and allows the user to use only a part of the feeding line. The mechanical switch in the mid-line stopper, stops the motor when the feed reaches to the mid line stopper.

Tavsan pan feeding system works without any problem up to 180 mt as a single line.

The special designed motor assures the highest performance.



KEMER

Thanks to its hinge system, Kemer feeder can be cleaned easily without the need to separate tray from the pan and it provides time and labor saving. The middle part design does not let the chicks to go inside the feeder in order to keep the feed clean from manure. The conic shaped pan tray distributes the feed equally all around the pan.

Feed flow diagram

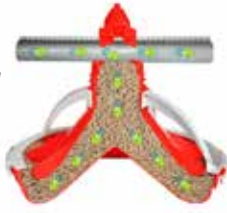

- The sliding feeder top offers an easy installation of the pan to the feed pipe.
- The special shape of the pan prevent the feed loss.
- The feed pan is composed of 4 main parts which allows an easy assembly and disassembly to the user.
- 5-stage feed height adjustment assures the required amount of feed to be filled into the feeders according to the age of the bird.



EFES

EFES pan feeders allows the chicks to reach to the feed starting from the first day with minimum feed loss. The height of the pan and the distance between the grills allows the chicks to get in and out of the feeder easily.



BODRUM

The ideal tray height and space between the grill arms in Bodrum feeder let the chicks to enter inside the feed pan during chick period.



BELEK / KAŞ

- The swinging tray of the feed pan allows an easy, fast cleaning with less labor.
- The integrated in feed stopper allows the user to stop the feed to go the pan whenever not needed. This feed stopper also prevents the water to go inside the pan feeding pipe during cleaning.
- Feed flow can be provided equally from the 'chick feeding window' from the feed pan's cone when the system is on the ground.
- The feed height level adjustment on the pan allows easy feed level adjustment in 6 different stages for each pan.



Belek feeder with 14 arm grill offers easy feeding to the birds. The KAS feeder with 10 arm grill having wider feeding space is proving the same advantages of Belek feeder to layers, rearing breeders, ducks and heavy broilers.

SIDE

- Provides chicks to enter into the feeder during chick period easily.
- Easy and fast cleaning thanks to hinge system.
- Conic shaped Belek tray enters the litter and comes to chicken level.



999

The 999 type feeder, which has proven its efficiency in broiler houses for many years, offers easy access from the first day and a very simple installation and cleaning process.



TECHNICAL SPECIFICATIONS

Maximum length of the system	150 m	
Feed pipe can be supplied	External diameter: 45mm Internal diameter: 42.6mm	
Standard drive unit	50Hz, 3 phase, 350rpm Special voltages and powers are available on request	
Conveying capacity	Approx. 450kg / hour	
Suspension	Recommended to be at every 3m	
Hopper Alternatives	90 kg	170 kg
Single outlet	√	√
Double outlet	√	√

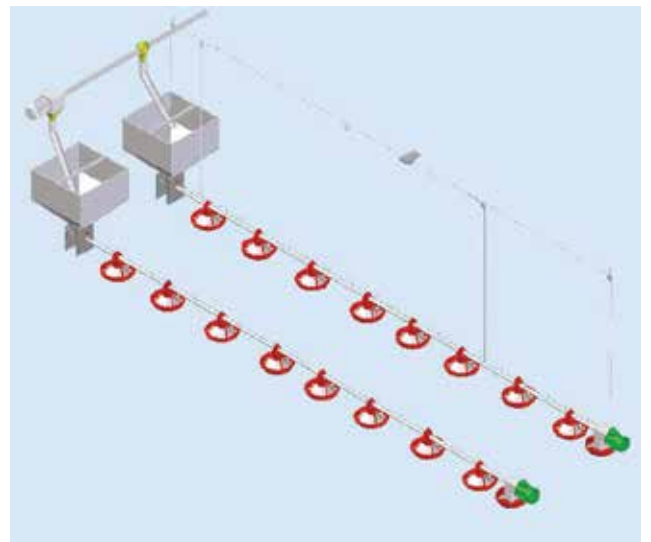

LIFTING

LIFTING WITH MOTORED WINCH

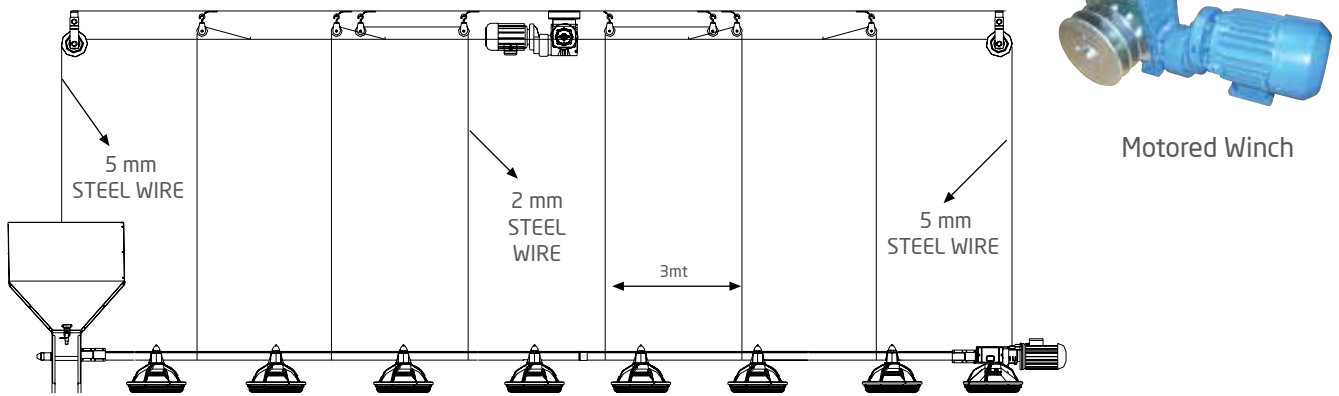

LIFTING WITH MANUAL WINCH

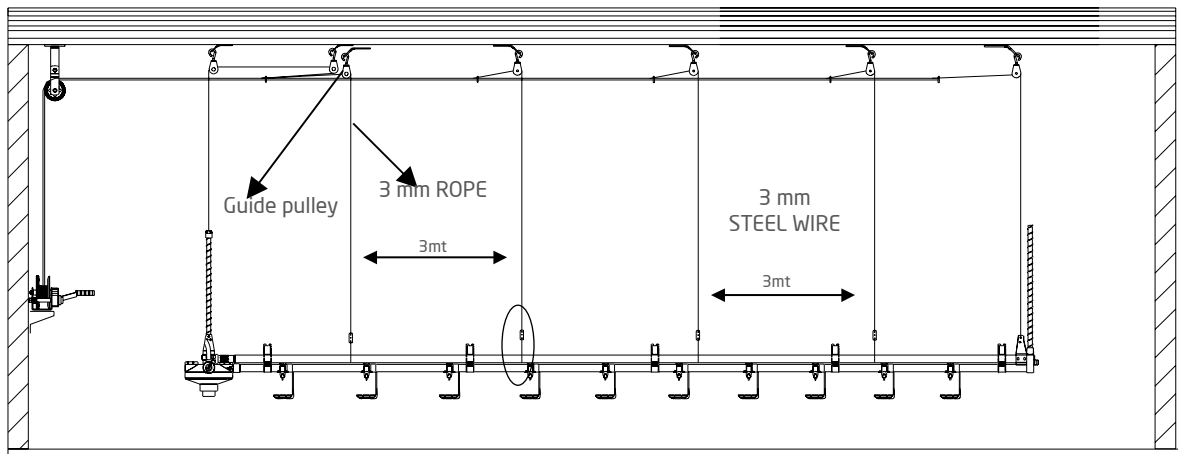

PULLEYS



80 mm
Steel Pulley



45 mm
Plastic Pulley



22 mm
Plastic Pulley

WALL & CEILING WINCHES



Wall winch 540 kg
For nipple watering up to 60 m



Ceiling winch with brake 900kg For pan feeding lines
up to 60 meters and nipple watering
lines upto 120 m



Vinç 1350 kg
For pan feeding over 60 m



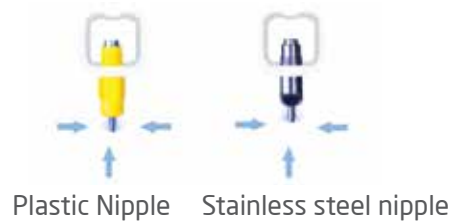
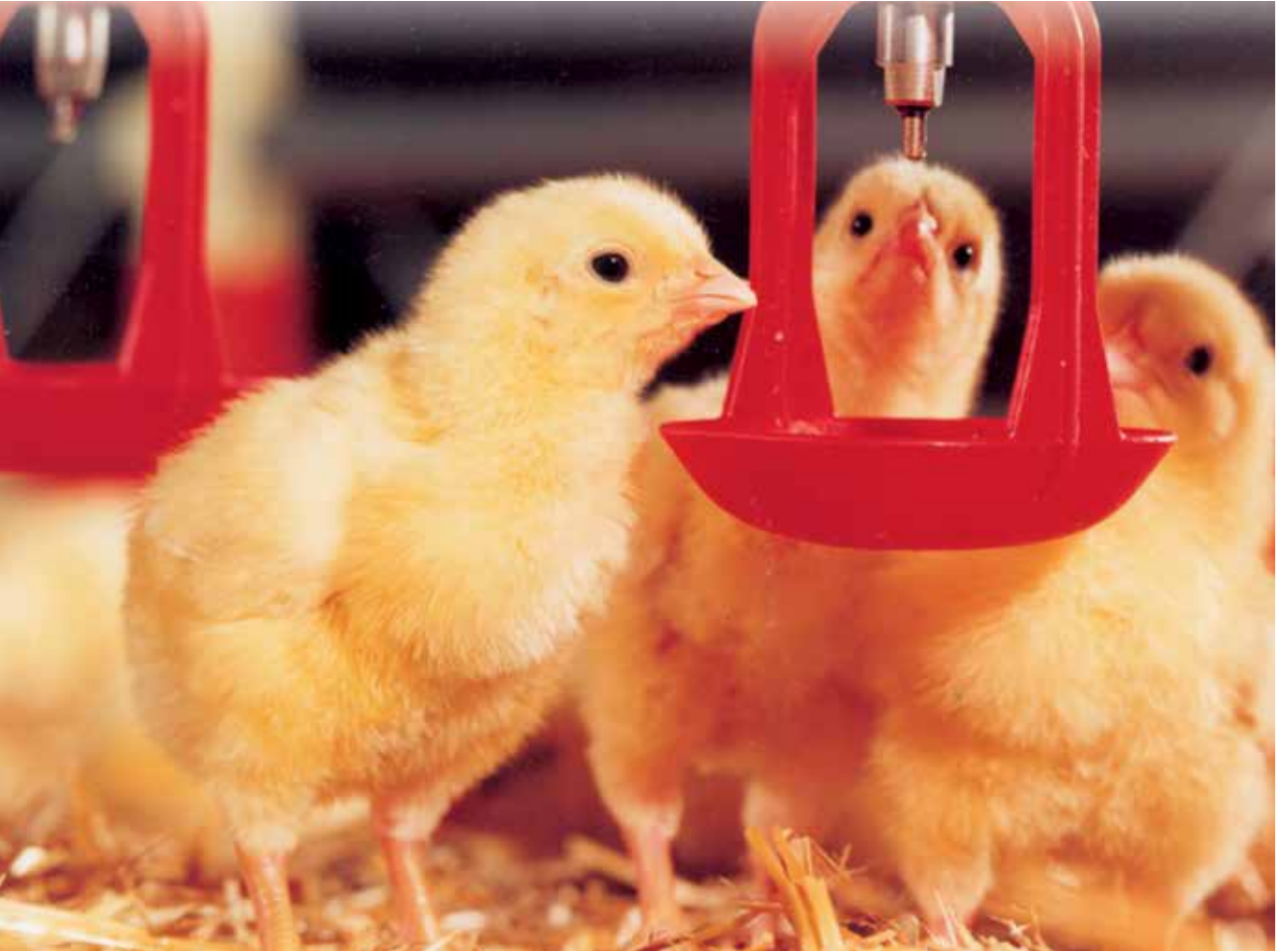

The high-quality stainless steel 'top-nipple' has a flow rate of 30-40 cm³/min with sideways and 70-80 cm³/min with upwards (at 3 mm vertical lift) action. All flow rates are valid for 20 cm water column. The nipple pipes can either be supplied by an aluminium profile or with a galvanized pipe support.

Alternatively the system can be supplied with "top-combi nipple" having the same flow rates. The only difference is that the outer housing of the stainless steel nipple is covered with a high-quality plastic. Top Nipple and Top-Combi Nipple watering units are available with single-arm and double arm dripcup.

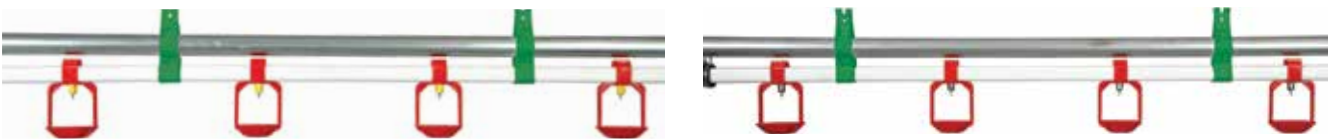

The nipples used in TAVSAN nipple watering system are made of top quality stainless steel. The plastic components offer a very long life time with their quality.

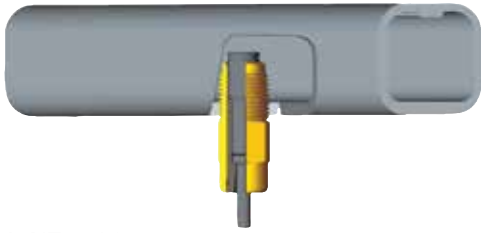

ADVANTAGES

- Offers water to the birds from day 0 until the slaughtering age.
- Offers continuous fresh and clean water
- Easy cleaning and maintenance
- High efficiency, problem free
- Offers dry litter

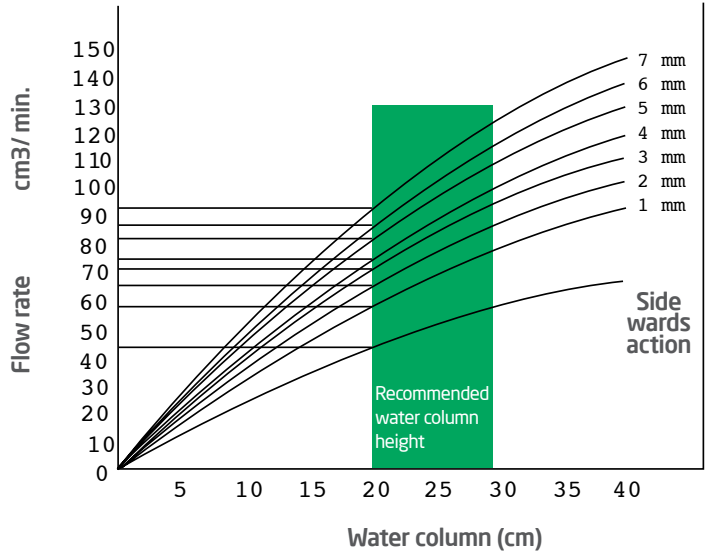

PRESSURE REGULATOR

Pressure regulator guarantees to supply the needed water in the correct pressure to the nipple watering lines



SLOPE REGULATOR

The slope regulator is used when there is a slope in the house are used in uneven houses. It has 3 versions for of delivery; 10cm, 15cm and 20cm slopes.



BREATHER UNIT WITH VALVE

Breather revolving unit is installed at the end of the drinking line.



FLUSH BREATHER UNIT

The flush breather unit also monitors the water pressure but offers a much more easier water flushing.

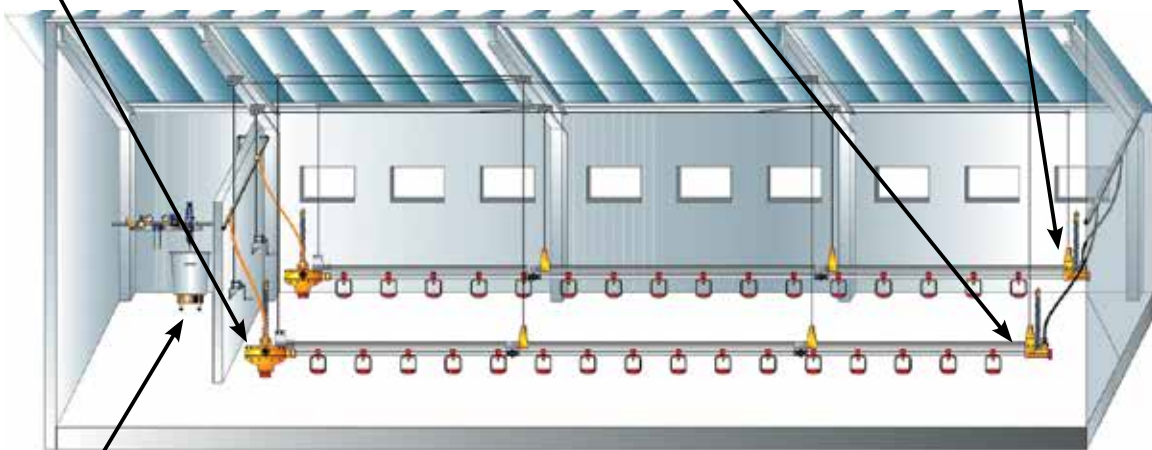

MIXER

The mixer offers the user to mix the vitamins and medicines with water continuously during medication process.



STARTER CUP

Starter cup offers fresh water to the chicks in the first days.



NIPPLE WATERING

COMBIMASTER NIPPLE



ADVANTAGES

- High quality materials provide highest stability and highest functional safety.
- The nipple body rises only 4mm inside the nipple pipe to offer much more easy cleaning.
- The extremely smooth inner surface and the outstanding hygienical characteristics of the plastic material avoid deposits.
- The larger body facilitate the birds to identify the nipple easily.
- Easy cleaning.
- Offers water to 12-14 broilers.

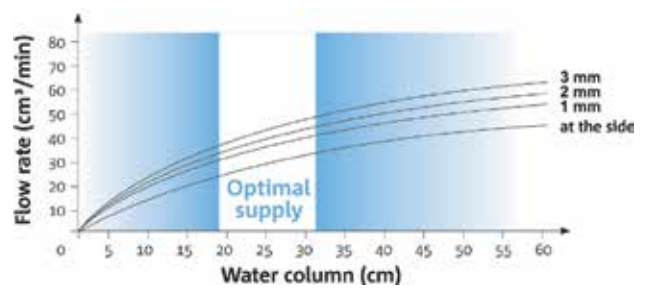

STAINLESS STEEL NIPPLE

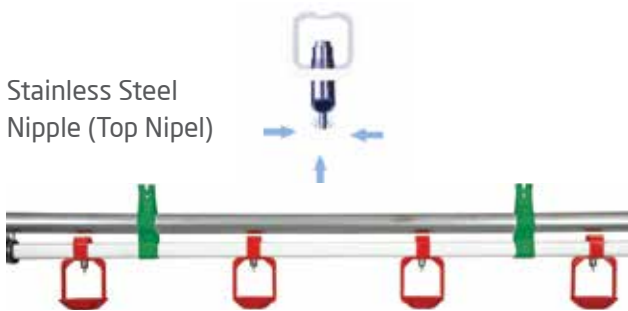

The nipples that are used in Tavsan nipple watering system are made of top quality stainless steel. The quality of the materials used for its plastic components is the guarantee of its long life span. The arrangement of the valve with a large cross section provides optimum water supply.

ADVANTAGES

- Possibility to drink from day one until the end of the cycle.
- Constant fresh and clean drinking water.
- Easy maintenance and cleaning.
- Productive and trouble-free operation.
- Dry manure.
- Helps all birds to rear equally in balance.

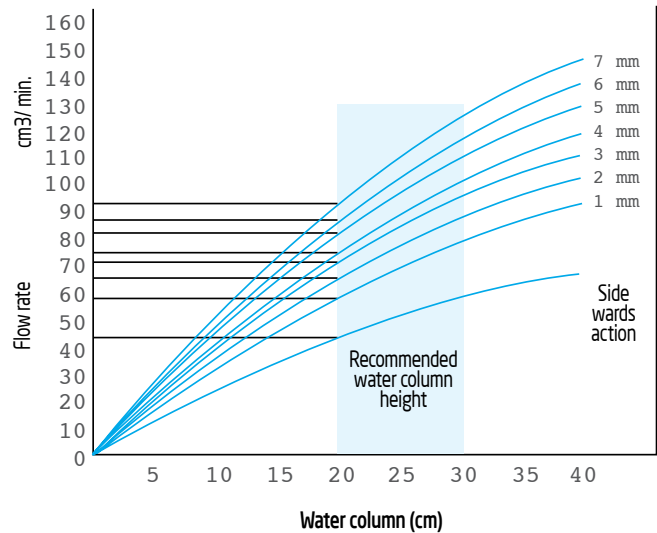

The nipples that proved their productivity on layer and breeder birds are made of stainless steel. The "top-nipple" has a flow rate of 30-40 cm³/min. with sideward's and 70-80 cm³/min. with upwards actions. All flow rates are valid for 20 cm water column.

MEDICATOR GROUP

This compact product is placed in poultry houses before nipple watering lines which offers all the needed controls for efficient watering.

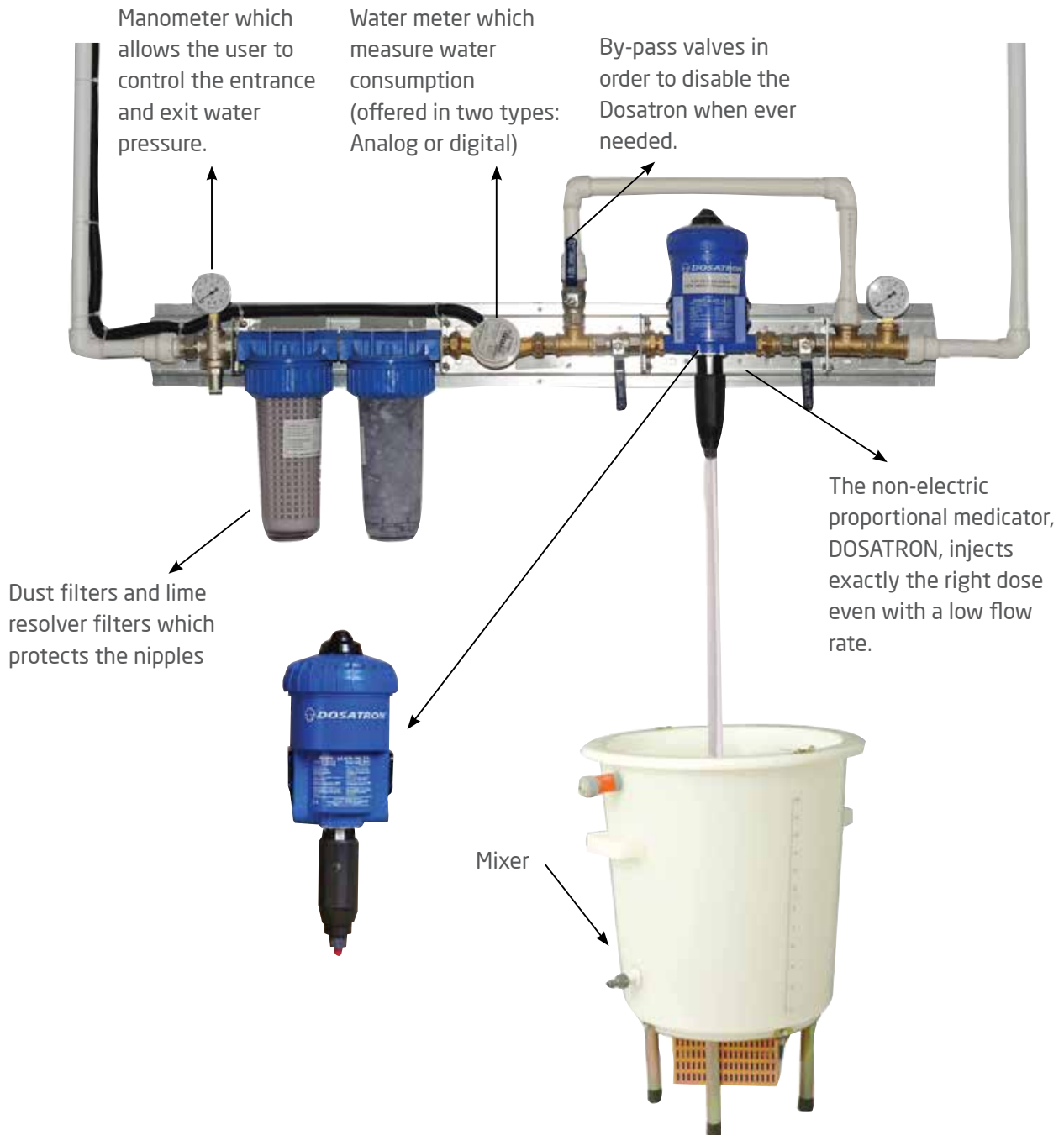

TECHNICAL SPECIFICATIONS

Adjustable dosage	% 0.2 - 2 [1:500 - 1:50]
Water flow rate	10 L\hour - 2.5 m3 \hour [0.16 L\min. - 41.66 L\min.] [1\3 US Pint\min. - 11 US GPM]
Operating pressure	0.3 - 6 Bar [4.3 PSI - 85 PSI]
Concentrate additive injection	0.02 L\Sa [0.011 US Fl oz\min.-0.22 US GPM]
Maximum water suction height	4 mt.

ADVANTAGES

- The dosage remains precise, regular and constantly proportional.
- The Medicator is completely hydraulic and so requires no electrical connections.
- Precise dosing avoids waste.
- The liquid dispenser is easily installed in the water line.



TavSan
444 6 887 www.tavsan.com.tr

TavSan
444 6 887 www.tavsan.com.tr



Tavsan silo and flex auger systems offers the user to store and transfer the feed fresh and clean.



1

The high-quality galvanization (350 gr/m² and the corrugation lead to an excellent light reflection and prevent any greenhouse effect inside the silo.



2

Mechanical filling kit is a standard in all of our silos. Pneumatic filling is an option. Should you require, both of the filling alternatives are available in a single silo.



3

The standard feed view window on the silo body allows you to check the feed level inside the silo.



4

The standard ladder, safety cage and handrail are designed for maximum safety.



5

Extended ladder to the ground level is also available, as an option.

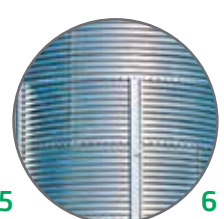

6

The thickness of funnel and roof sheet is 1,2 mm



Drop kit operated manual



Drop kit with automated valf



Feed in take boot alternatives

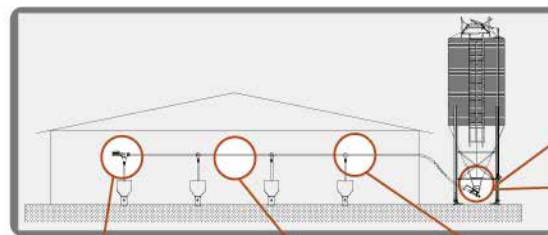

90 mm, 75 mm or 125 mm DRIVE UNIT

90 mm, 75 mm or 125 mm PVC PIPE

90 mm, 75 mm or 125 mm DROP OUTLETS

- TAVSAN silos are produced suitable to be filled with two types; Mechanical filling and Pneumatic filling.
- Mechanical filling silos, the feed is filled through the top cover which can be easily opened with an arm.
- Pneumatic filling silos the feed is delivered to the silo with air pressure. This way the feed trucks does not enter to the farm which offers high biosecurity.
- It is also possible to fix a cyclon on the top of the

silos. This way the feed which is delivered from the truck by high air pressure comes first to the cyclon and slows down and then enter to the silo. This offers less damage on the pallet and also stops the dust which appears during filling process.

- Pneumatic silos, the feed filling pipes can be offered with two options; with flange and with coupler.

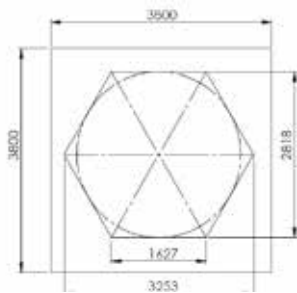
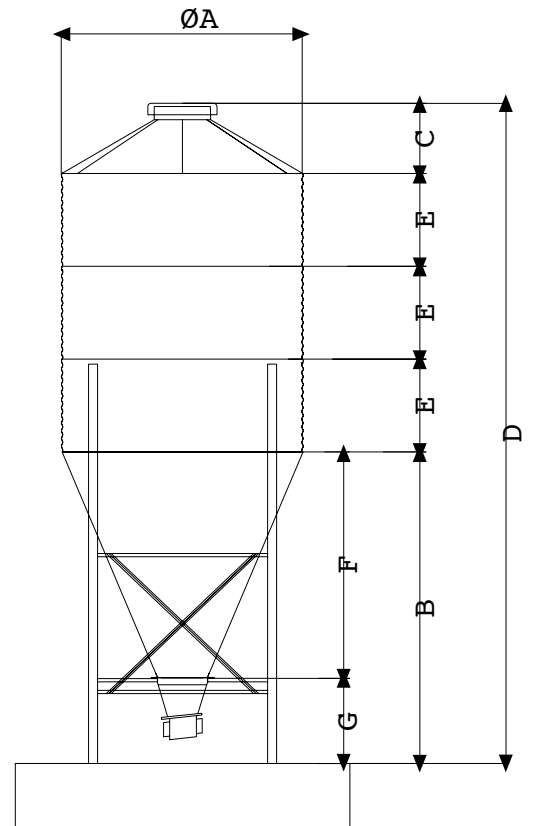
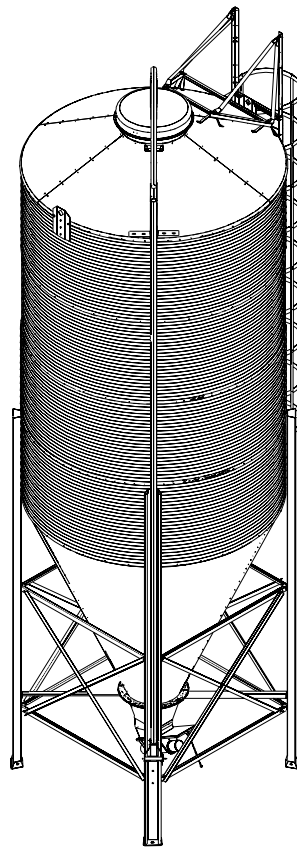
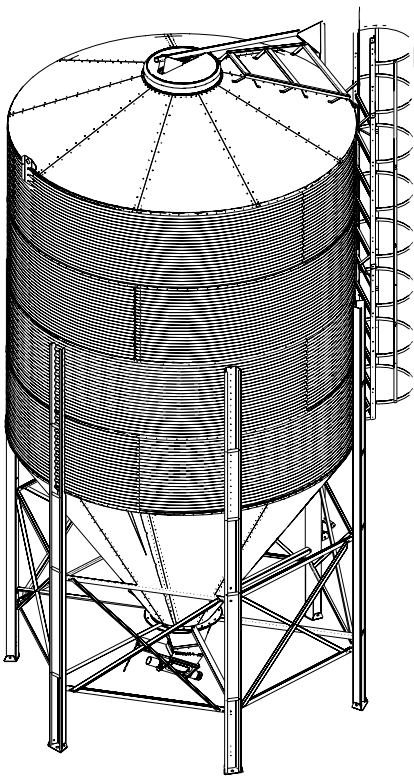

25 Ton silo concrete dimensions

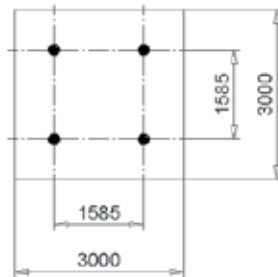

Base concrete drawing for 4-leg silos

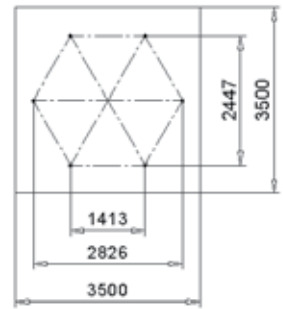

Base concrete drawing for 6-leg silos

6 LEG SILOS										4 LEG SILOS											
CAPACITY Ton	CAPACITY m ³ VOLUME	DIMENSIONS (mm)								NUMBER OF RINGS	CAPACITY Ton	CAPACITY m ³ VOLUME	DIMENSIONS (mm)								NUMBER OF RINGS
		A	B	C	D	E	F	G	A				B	C	D	E	F	G			
10.5	15.6	2742	2730	515	4855	805	2145	585	2	6	9.4	2150	2730	500	4850	810	2145	585	2		
13.5	20.5	2742	2730	515	5715	805	2185	600	3	8	12.1	2150	2730	500	5660	810	2145	585	3		
16.5	25.25	2742	2730	515	6520	805	2185	600	4	10	14.8	2150	2730	500	6470	810	2145	585	4		
19.5	30.25	2742	2730	515	7325	805	2185	600	5	12	17.5	2150	2730	500	7335	810	2145	600	5		
25	37	3186	3291	1208	7790	810	2527	764	4												



EXTENSION BOOTS

When the capacity of the standard flex auger system is not enough, feed extension boots can be used to deliver the feed to longer distances.

WEIGHING SYSTEM WITH LOADCELLS

Feed quantity inside the silo can be monitored and restored when loadcells are used with appropriate controller. Restricted feed delivery is possible.



90° Extension booth



180° Extension boot

TECHNICAL SPECIFICATIONS

Feed transport system	75 mm	90 mm	125mm
Feed transport capacity	1300 Kg/h	2700 Kg/h	5400 Kg/h
Max. length of the system with inclination maximum	60 m	42 m	30 m
Max. length of the system straight line maximum	72 m	51 m	36 m
Max. length of the system with 1 extension boot maximum	117 m	81 m	50 m
Standard drive-unit* specifications	0,55Kw 0,75Hp 350 rpm	0,55Kw 0,75Hp 350 rpm	1,1Kw 1.5Hp 290rpm
PVP pipe outer diameter	75 mm	90 mm	125 mm
PVP pipe wall thickness	3,6 mm	4,0 mm	5 mm
Maximum inclination of the system	75°	75°	75°

*0,75Kw / 1Hp drive-unit available as an option

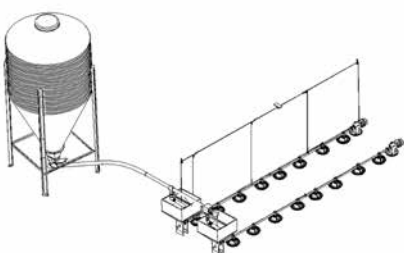

BELL DRINKERS



DICLE BELL DRINKER

The ideal bell drinker that can be used for broilers, layers and breeder rearing. The weight ball mechanism allows the drinkers to work automatically on the floor as well as suspended.



- 1 CORD ADJUSTER
- 2 HANGER CORD
- 3 HOSE HOLDER
- 4 HOSE INLET
- 5 NUT FOR HOSE INLET
- 6 MECHANISM CAP
- 7 FILTER
- 8 O-RING FOR MECHANISM CAP
- 9 MECHANISM PIPE
- 10 WATER LEVEL ADJUSTER
- 11 NUT FOR LEVEL ADJUSTER
- 12 MECHANISM SPRING
- 13 SPRING FOR VALVE
- 14 PIN FOR VALVE
- 15 WASHER FOR VALVE PIN
- 16 WASHER FOR VALVE
- 17 VALVE BODY

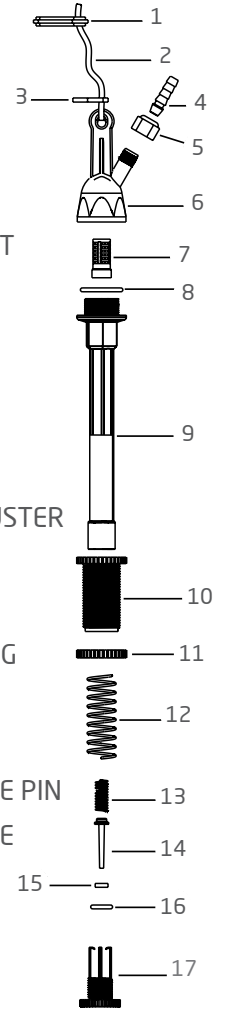

MANUAL FEEDERS & DRINKERS



Suspended Feeder-10 kg



Bucket Feeder-8 kg

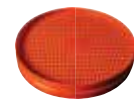

Tray Feeder

TECHNICAL SPECIFICATIONS

Diameter (mm)	352	278	353
Rim height (mm)	67	38	33
Rim width (mm)	33	40	

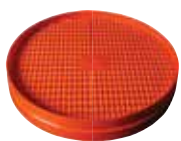

TRAY FEEDER

The corrugated pan surface attracts the chicks to feed and also prevents them to slip on the pan.

5 lt. CHICK DRINKER



BUCKET FEEDER 8 kg



These two manual feeders are suitable to be used in chick period of broilers and also for the first phase of pullet rearing.



Tavsan promotes the poultry sector ahead through its glamorous new led product.

DIMMABLE LED STRING LIGHT BULB

- LED energy saving lamp (8W- 3000 K - 75W incandescent bulb).
- 230V-50/60 Hz, fixing directly to flat cable.
- Available light colours: warmwhite 3000 K.
- High efficiency up to 112 lm/w.
- Average lifetime > 30.000h.
- Perfectly dimmable from 0-100% brightness with iLOX dimmer EPU-1500.
- Non flickering light - FI = < 0,03.
- Fast and flexible fixing.
- Wide beam angle.
- No extra housing needed.
- Dust and waterproof IP68.



LED PERFORMANCE CRITERIA

Voltage	Nominal luminaire input voltage	220-240V 50/60Hz
Mounting method	Screw mount	Fixing directly to flat cable
Led driver	Dimmable	0 - 100%
Ingress protection	IP Rating	IP68
Thermal environment	Min. operating temperature	-20°C
	Max. lighting temperature	80°C
Nominal CCT	3000°K	
Color	Warmwhite	
Weight	120 gr	
Lumen	900 Lumen / 112 lm/w	
Watt	8 W	
Life Span	Over 30.000 hours	

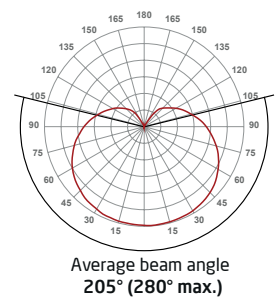
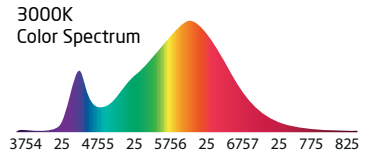

EPU-1500 ELECTRONIC DIMMER CONTROLLER

- 220VAC Universal controller/AC-dimmer for LED.
- Load 1500VA-max.
- intelligent microprozessor-MOSFET-controller.
- Adjustable to trailing-edge or leading-edge- dimming.
- RS485-digital-interface- communication.
- Protection of overheating/overload/shortcircuit/undervoltage.
- Alarm signalization by buzzer-beep and LEDs.
- VDE certified and IP20 protection class.
- Power supply 220V-50/60Hz .
- Dimensions: 105*90*60mm W*H*D.







Tavsan Tavukçuluk Ekipman San. ve Tic. A.Ş.

Şerifali Mahallesi Mevdudi Sokak Tavsan Plaza No:10 34775 Ümraniye / İstanbul - TÜRKİYE
T. +90 444 6 887 / F. +90 (216) 364 66 30 / tavsan@tavsan.com.tr / www.tavsan.com.tr